

PROJECT	TYPE	NOTES
<p><b>OVERVIEW</b></p> <p>The WMSL24 is a 24VDC wall mount sign light that utilizes our TL24COB-H0 series tape light. Aside from the arms, it comes pre-assembled. It's asymmetric beam spread helps wash the sign/wall with light. Maximum length is 48".</p>		



IP20



**DIMENSIONS**

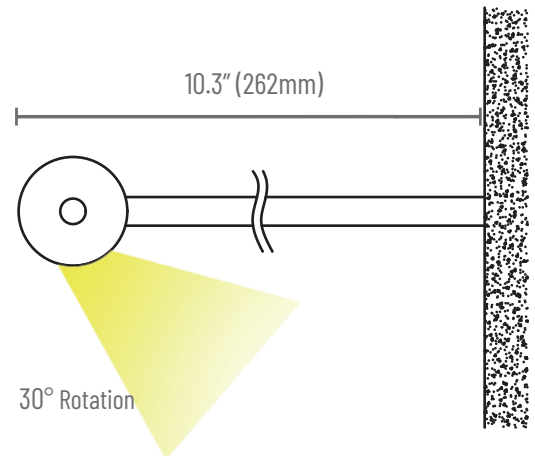
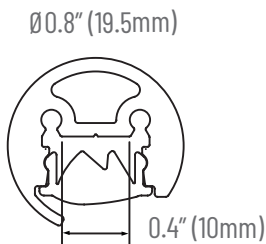
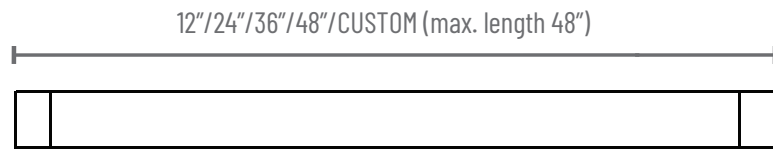

TECHNICAL SPECIFICATIONS

Operating Voltage	24VDC
Power Consumption	3.0W/ft
Lumens/ft (3000K)	297lm/ft
Efficacy (3000K)	99lm/W
Dimming Levels	0.1% (0-10V) 1% Phase
Color Temperatures	2400K, 2700K, 3000K, 3500K, 4000K
Beam Angle	Asymmetric 60° x 120°
LED Life	50,000 hrs
Lengths	12"/24"/36"/48"/CUSTOM
Max. Length	48"
Warranty	5 years

ORDER CODE

WMSL24	-	-	-
--------	---	---	---

**CRI / CCT**

- 924 - 90+ / 2400K
- 927 - 90+ / 2700K
- 930 - 90+ / 3000K
- 935 - 90+ / 3500K
- 940 - 90+ / 4000K

**LENGTH**





- 12 - 12"
- 24 - 24"
- 36 - 36"
- 48 - 48"
- XX - Custom

**FINISH**

- AA - Anodized Aluminum
- BL - Black
- WH - White



DRIVER CUTSHEETS

DESCRIPTION	INPUT	OUTPUT	WATTAGES	SPECIFICATION SHEETS	
Non-Dimming Indoor-Outdoor	90-305VAC	24VDC	40W-480W	DR-24VDC-OUT	
Phase Dimming Indoor	100-130VAC	24VDC	24W-60W	DR-24VDC-DIMA	
0.5% & 1% Universal Dimming	100-277VAC	24VDC	30W-300W	DR-24VDC-DIMS-UNV	
0.1% & 1% Universal Dimming	120-277VAC	24VDC	96W	DR-24VDC-DIML-UNV	

VOLTAGE DROP CALCULATOR

LOAD (WIRE GAUGE)	10W	20W	30W	40W	50W	60W	70W	80W	90W	100W
20AWG	85 ft	43 ft	27 ft	21 ft	17 ft	14 ft	12 ft	11 ft	9 ft	8 ft
18AWG	134 ft	68 ft	45 ft	33 ft	27 ft	22 ft	19 ft	17 ft	15 ft	14 ft
16AWG	215 ft	109 ft	72 ft	54 ft	43 ft	36 ft	31 ft	27 ft	24 ft	22 ft
14AWG	345 ft	174 ft	115 ft	86 ft	69 ft	57 ft	49 ft	43 ft	39 ft	36 ft
12AWG	539 ft	272 ft	181 ft	135 ft	108 ft	90 ft	77 ft	68 ft	61 ft	56 ft
10AWG	784 ft	397 ft	263 ft	197 ft	158 ft	131 ft	112 ft	98 ft	87 ft	82 ft

